

Free eNewsletter

Enter your E-mail



Shop By Type

Cable Assemblies
Adapters
Connectors
Rack Panels
Bulk Cable
Tools
Switch Boxes
Network Cards
Hubs & Switches
Converters & Transceivers
KVM Switches
Antennas

Overstock/Sale Items
Top 10 Products

Shop By Category

IEEE-488 GPIB
Coaxial
Monitor, Video
Fiber Optic
D-Subminiature
Modular
USB, DIN, Firewire, SCSI, and Others
Wireless Infrastructure
Weatherproof Enclosures
Networking and Other Equipment

Product Wizards

Cable Assemblies
Adapters
Connectors
Rack Panels
Tools
Switch Boxes
Network Cards
Hubs or Switches
Ethernet Converters
KVM Switches

Technical Resources

FAQs
Connector Chart
Glossary
Tutorials
Tips and Videos
White Papers
Catalog Downloads
eNewsletter Archive

You Are Here: [Home](#) > [Modular](#) > [Adapters, Couplers, Splitters](#) > [Modular Couplers](#) > [ECF504B](#) > **ECF504B-6S**

Modular Coupler, RJ12 (6x6), Straight, 50μ, Black, Deluxe Panel

L-com's exclusive line of category 3 panel mount connectors is the perfect choice for passing modular cables through a rack panel or wall plate. The unique flange mount design accepts #4 or #5 screws for secure mounting of these couplers to any panel (purchased separately). Contacts have 30 microinches of gold plating for durability and the black plastic shell is UL94V-0 rated. With a category 3 rating these couplers can be used for either voice or data applications. Large volume discounts offered; Call today.



Features for this Modular product

- Category 3 RJ45 Panel Mount Coupler, USOC Straight wired for voice or data applications
- Flange mount design accepts #4 or #5 screws for secure panel mounting
- 30 microinches gold plating for a durable connection
- UL94V-0 rated ivory plastic shell for ruggedness
- Category 3 rated for data and voice applications

Details for this Modular product

L-com Item #	ECF504B-6S
Manufacturer	L-com
ASIN # (More)	B000AAL6VW
UPC # (More)	822335022393
RoHS Status	RoHS Compliant (More)

[Diagram](#)

[Catalog Page](#)

[2D Drawing \(.pdf\)](#)

[3D CAD Model \(.step\)](#)

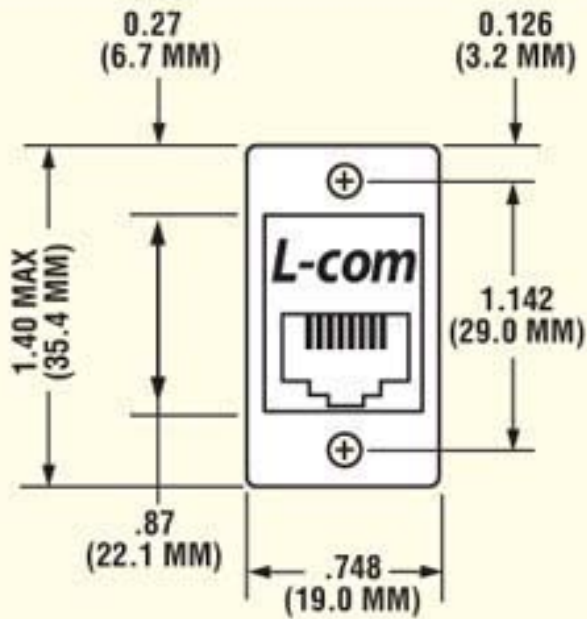

ECF & ECJ Front View

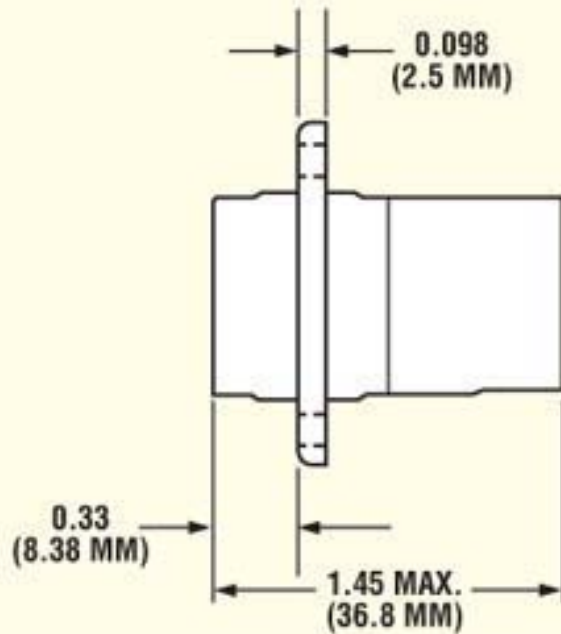

ECF Side View

USB Style Connectors

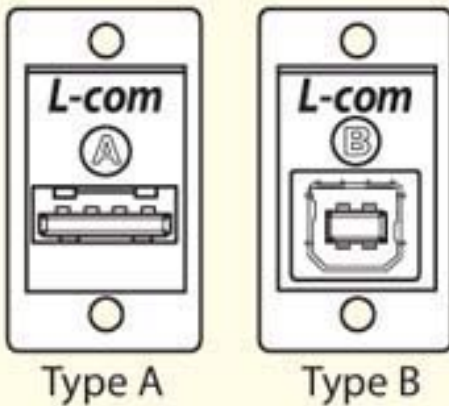

USB Type A & B

ECF & ECJ Series
RECOMMENDED PANEL
HOLES

DRILL AND TAP
HOLES FOR
4-40 SCREW

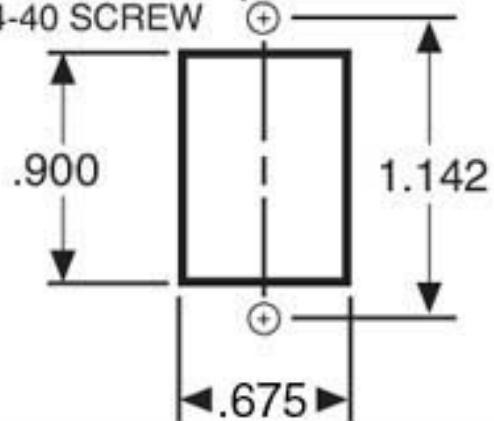

ECF504 Series



Network Rating: Category 3
Color: Ivory
Gold Plating: 30 microinches
Flammability Rating: 94V-0

ECJ504 Series Front View



ECJ504 Series Rear View

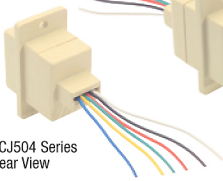

Color: Ivory
Gold Plating: 30 microinches
Flammability Rating: 94V-0

ECF504B Series



Network Rating: Category 3
Color: Black
Gold Plating: 50 microinches
Flammability Rating: 94V-0



PR175F504-6S

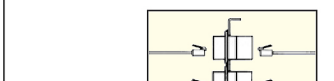

PR175F504-8SK



PR175F504-6C



PR175F504-8C



PR35F504-6S

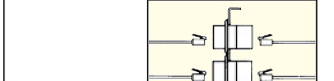

PR35F504-8SK



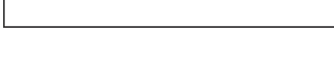

PR35F504-6C



PR35F504-8C

Item #	Description	Color	1-9	10-24	25-99	100-249	250-499
 Deluxe Panel Mounted Modular Couplers, 30 Microinches Gold, Ivory Color							
ECF504-4C	Modular Coupler, RJ11 (6x4), Crossed, 30µ	Ivory					
ECF504-6C	Modular Coupler, RJ12 (6x6), Crossed, 30µ	Ivory					
ECF504-6CMJ	Modular Coupler, MMJ (6x6), Crossed, 30µ	Ivory					
ECF504-8C	Modular Coupler, RJ45 (8x8), Crossed, 30µ	Ivory					
ECF504-4S	Modular Coupler, RJ11 (6x4), Straight, 30µ	Ivory					
ECF504-6S	Modular Coupler, RJ12 (6x6), Straight, 30µ	Ivory					
ECF504-6SMJ	Modular Coupler, MMJ (6x6), Straight, 30µ	Ivory					
ECF504-8SK	Modular Coupler, RJ45 (8x8K), Straight, 30µ	Ivory					
ECF440	Machine Screws, 4-40 x 5/16", Pkg/100						

 Deluxe Panel Mounted Modular Jacks - 10" Wire Leads, 30 Microinches Gold, Ivory Color							
One difficulty in using modular jacks is the mounting problem on a panel. L-com's solution to this problem is providing a flange that mounts with two screws in a 0.675" x 0.900" rectangular opening. Choice of RJ11/12 (6x6) or RJ45 (8x8K) usable with keyed or non-keyed plugs. Custom versions of other jack types considered in quantities of 500/up. Mounting screws must be purchased separately.							
ECJ504-6	Modular Panel Jack, RJ12 (6x6) / Wires, 30µ	Ivory					
ECJ504-8	Modular Panel Jack, RJ45K (8x8K), / Wires, 30µ	Ivory					
ECF440	Machine Screws, 4-40 x 5/16", Pkg/100						

 Deluxe Panel Mounted Couplers, 50 Microinches Gold, Black Color							
These couplers are similar to the ECF504 Series with two changes. The molding has been changed to a black color for applications when ivory is not wanted. Also, the contacts have 50 microinches of gold for superior mating with modular plugs. Mounting screws must be purchased separately. Category 3 rated.							
ECF504B-4S	Modular Coupler, RJ11 (6x4), Straight, 50µ	Black					
ECF504B-6S	Modular Coupler, RJ12 (6x6), Straight, 50µ	Black					
ECF504B-8SK	Modular Coupler, RJ45K (8x8K), Straight, 50µ	Black					
ECF440	Machine Screws, 4-40 x 5/16", Pkg/100						

 19" Patch Panels - Equipped with 16 or 32 ECF504 Series Modular Couplers							
These 19" patch panels utilize the ECF504 series couplers. For your convenience, two panel heights are offered; 1.75" with 16 modular adapters or 3.5" with 32 modular adapters. Panel legend is 1-16 or 1-32. Color: Bone. Available in straight or crossed wiring.							
PR175F504-6S	1.75" 16 Port Panel RJ12 (6x6), Straight-Thru	Bone					
PR175F504-8SK	1.75" 16 Port Panel RJ45 (8x8), Straight, Keyed	Bone					
PR175F504-6C	1.75" 16 Port Panel RJ12 (6x6), Crossed	Bone					
PR175F504-8C	1.75" 16 Port Panel RJ45 (8x8), Crossed	Bone					
PR35F504-6S	3.50" 32 Port Panel RJ12 (6x6), Straight-Thru	Bone					
PR35F504-8SK	3.50" 32 Port Panel RJ45 (8x8), Straight, Keyed	Bone					
PR35F504-6C	3.50" 32 Port Panel RJ12 (6x6), Crossed	Bone					
PR35F504-8C	3.50" 32 Port Panel RJ45 (8x8), Crossed	Bone					

How Rack Spaces and Sizes are Measured

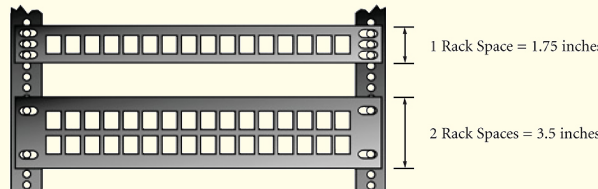

Racks are a great way to neaten up wiring closets and labs. Network equipment and rack panels usually come in 1.75", 3.5" and 5.25" heights. (1, 2 and 3 rack spaces).

 19" Modular Patch Panels - Equipped with 16 or 32 ECF504B Modular Couplers							
These panels utilize the ECF504B couplers with 50 microinch plating. 16 and 32 port available. Straight thru pinned only. Color: Black.							
PR175F504B-4S	1.75" 16 Port Panel RJ11 (6x4), Straight-Thru	Black					
PR175F504B-6S	1.75" 16 Port Panel RJ12 (6x6), Straight-Thru	Black					
PR175F504B-8SK	1.75" 16 Port Panel RJ45 (8x8), Straight, Keyed	Black					
PR35F504B-4S	3.50" 32 Port Panel RJ11 (6x4), Straight-Thru	Black					
PR35F504B-6S	3.50" 32 Port Panel RJ12 (6x6), Straight-Thru	Black					
PR35F504B-8SK	3.50" 32 Port Panel RJ45 (8x8), Straight, Keyed	Black					